

SUPERFLY™ Best Value Vises & Accessories

VICES

SUPER AA VISE

Simple single-lever operation. Chrome or black no-glare finish.

- A-5005 Black (Pictured)
- A-5006 Chrome

CROWN VISE

Spring lever for easy operation.

- A-5007 C-Clamp (Pictured)
- A-5008 Pedestal Base with Wood Presentation Box

PREMIUM VISE

Brass pipe fixed in the clamp. Vise height can be adjusted with the help of vise shaft. Fine jaws.

- A-5010 C-Clamp (Pictured)

KNOB VISE

Single wheel operation with angle adjustment.

- A-5013 Chrome (Pictured)

FLY KING VISE

An easy to use vise for beginners. Black or chrome finish.

- A-5014 Black (Pictured)
- A-5015 Chrome **NEW!**

F.T. VISE

Angle adjustment facility.

- A-5016 C-Clamp (Pictured)

MINI A VISE

Our most economical vise.

- A-5017 Black (Pictured)

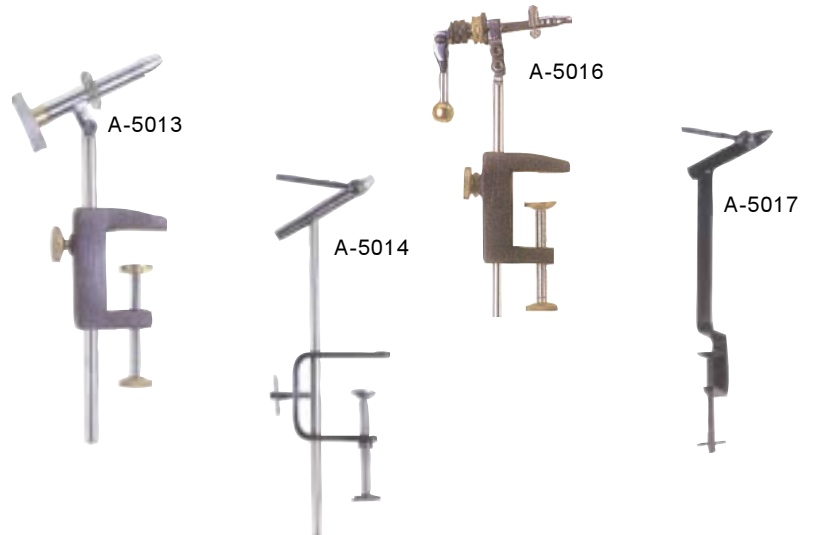

EZ ROTARY VISE

Excellent quality at an affordable price. Precision machined stainless steel and aluminum components.

- A-2001 C-Clamp
- A-2002 Pedestal Base (Pictured)

EZ ROTARY VISE ACCESSORIES

- A-2005 EZ Pedestal Base
- A-2006 EZ Spare Jaw



WISE ACCESSORIES

- A-0311 Hook & Hackle Gauge
- A-1239 Material Clip Clamp-on
- A-624 Tube Vise Converter **NEW!**
- A-708 Waste Tool with Bag **NEW!**
Attaches to the vise so tyers can keep their work area tidy.
- A-8120 Midge Jaws - Insert fits most vises. **NEW!**
- A-8615 Spring Material Clip

Take advantage of our Assembly Discount on all SUPERFLY™ Best Value Vises & Accessories and save money!

6 SAME CODE LESS 5%

HMH Vises & Accessories

SUPERFLY™ is pleased to add the HMH product line to our inventory. For over 25 years, HMH has set the standard for quality fly tying vises. All HMH vises are manufactured using the finest materials available, incorporating the stainless steel chassis with a bronze bearing system and tighter tolerances for improved rotary performance. Thanks to their versatility and durability, HMH vises are certain to remain the most trusted and reliable item on any fly tyer's bench.

VICES

SPARTAN

An affordable, compact vise with all the performance features of full-sized professional vises.

H-1001P Pedestal (Pictured)
H-1001C C-Clamp

STANDARD BENCH

This full-sized vise comes with the Omni jaw, a fleece-lined vise pouch and hex wrench set.

H-1002P Pedestal (Pictured)
H-1002C C-Clamp

STANDARD PRO

A professional model vise comes with the Omni and Magnum jaws. Other features include a bobbin rest, a fleece-lined vise pouch and hex wrench set.

H-1003P Pedestal (Pictured)
H-1003C C-Clamp

JAWS

HMH offers the simplest, most versatile and powerful jaw system available. Constructed from hardened tool steel with a polished, non-glare finish.

H-4140J Magnum Jaw - For hook sizes to 10/0
H-4190J Micro Jaw - For hook sizes 20 - 32
H-4200J Omni Jaw - For hook sizes 20 - 4/0

WISE ACCESSORIES

H-PK 4 lb. Black Pedestal Base Kit
Heavier black pedestal base with brass knurled knob and 6" stainless standrod.

H-CK C-Clamp Kit
Black c-clamp with brass fittings, including swivel head for best grip and 9" stainless standrod.

H-PVP Pedestal Vise Pouch
2-pocket, fleece-lined pouch for pedestal vises.

H-CVP C-Clamp Vise Pouch
Fleece-lined nylon pouch for c-clamp vises.

H-BR Bobbin Rest
Delrin, brass and stainless steel.

H-PP Profile Plate
6" square white plate, stem-mounted for best view of flies while tying.

H-BC Profile Backing Card - White



H-1001P
Spartan



H-1002P
Standard Bench



H-1003P
Standard Pro



All HMH vises feature 360° rotation with tension adjustment, adjustable head angle, a quick-change jaw system, a powerful sure-lock cam for superior hold, stainless steel and brass components and a Lifetime Guarantee.



HMH Tubes & Tools

TUBE FLY TOOLS

PREMIUM TUBE FLY TOOL

Code: H-1100T

Fits any vise and holds tubes tight. Features two tapered mandrels (.062" and .042" diameters) and button end. Stainless steel and brass components.



STARTER TUBE FLY TOOL

Code: H-1101T

Comes with a straight, stainless steel pin and bead end.



PINS & MANDRELS

- H-PM-42 Premium Mandrel - .042" diameter
- H-PM-62 Premium Mandrel - .062" diameter
- H-SPS Starter 2-Pin Set - .042" and .062" diameters

TUBES

Best-quality plastic and metal tubes. Plastic tube ends with thread-stop flange. Aluminum and brass lined with plastic.

PREMIUM SINGLE-WALL PLASTIC - LARGE

Floating. 1/8" OD x .062" ID

10 /pkg

H-TA05	.5"	H-TA20	2"
H-TA10	1"	H-TA25	2.5"
H-TA15	1.5"	H-TA30	3"

PREMIUM SINGLE-WALL PLASTIC - SMALL

Floating. 3/32" OD x .042" ID

10 /pkg

H-TE05	.5"	H-TE20	2"
H-TE10	1"	H-TE25	2.5"
H-TE15	1.5"	H-TE30	3"

PREMIUM DOUBLE-WALL PLASTIC

Floating. 1/8" OD x .062" ID

10 /pkg

H-TB05	.5"	H-TB20	2"
H-TB10	1"	H-TB25	2.5"
H-TB15	1.5"	H-TB30	3"

PREMIUM ALUMINUM PLASTIC-LINED

Intermediate. 3/32" OD x .042" ID

10 /pkg

H-TC05	.5"	H-TC20	2"
H-TC10	1"	H-TC25	2.5"
H-TC15	1.5"		

PREMIUM HEAVY BRASS PLASTIC-LINED

Fast sink. 1/8" OD x .062" ID

10 /pkg

H-TD05	.5"	H-TD20	2"
H-TD10	1"	H-TD25	2.5"
H-TD15	1.5"		

CUT-TO-LENGTH (CTL) TUBES

H-TCL	1/8" OD x .075" ID (12 /pkg)
H-TCS	3/32" OD x .042" ID (12 /pkg)
H-TCX	Micro Tube (24" piece)

LARGE DIAMETER JUNCTION TUBING

Fits CTL, Single- and Double-Wall Premium Plastic and Heavy Brass. 1/8" ID.

12"

H-JTL-18	Chartreuse	H-JTL-14	Pink
H-JTL-00	Clear	H-JTL-19	Purple
H-JTL-08	Olive		

SMALL DIAMETER JUNCTION TUBING

Fits small CTL, Small Premium Plastic and Aluminum. 1/16" ID.

12"

H-JTS-18	Chartreuse	H-JTS-14	Pink
H-JTS-00	Clear	H-JTS-19	Purple
H-JTS-08	Olive		

ASSORTED TUBE PACK

Code: H-TAST

Contents:

- Small Cut-to-Length Tubes (6)
- Large Cut-to-Length Tubes (6)
- Premium 2" Single-Wall Plastic Large (3)
- Premium 1" Single-Wall Plastic Large (3)
- Premium 2" Aluminum (3)
- Premium 1" Aluminum (3)
- Premium 2" Brass (3)
- Premium 1" Brass (3)
- 12" Small and Large Clear Junction Tube

New to Tube Flies?

Noted tyer and fly tying columnist, Dick Talleur, offers a host of new tying techniques and materials, along with some innovative patterns in these instructional videos:

- V-33 Introduction to Tube Flies
by Dick Talleur
- V-34 Tube Fly Patterns & Techniques
by Dick Talleur

Griffin Vises

VICES

SUPERIOR 1A

Code: G-V-00 (Pictured)

Features a fixed head and solid 3/8" shaft. Griffin's entry model. One-year warranty.

SUPERIOR 2A

Code: G-V-01 (Pictured)

High quality vise at an economical price. Features include positive adjustment to hook sizes, easy conversion for right or left hand tyers, jaws adjustable to any angle, front or rear tension mode. Lifetime warranty.

SUPERIOR 3A ROTARY C-CLAMP

Code: G-V-02

This c-clamp mounted vise features the same advantages as the 2A, as well as 360° rotation. Lifetime warranty.

SUPERIOR 3AR ROTARY PEDESTAL

Code: G-V-03 (Pictured)

Combines the features of the 2A and 3A Rotary C-Clamp vises, with a pedestal mount. Also comes with a c-clamp. Lifetime warranty.

PATRIOT ROTARY PEDESTAL/C-CLAMP

Code: G-V-05 (Pictured)

Features total hook pressure control, 360° rotation and adjustable jaws that set to various angles. Includes both a pedestal base and c-clamp for maximum versatility. Lifetime warranty.

ODYSSEY C-CLAMP

Code: G-V-07 (Pictured)

Includes 360° true rotation and easy hook adjustment. Works for both left- and right-handed tyers. Comes with a material clip and bobbin cradle. Lifetime warranty.

ODYSSEY PLUS

Code: G-V-08

Carries the same features as the Odyssey C-Clamp, along with the ability to convert to a line winder. Comes with an empty line spool and has adjustable rotation.

TUBE VISE

Code: G-V-09

The varied sizes of tying stems and a non-rotating edge on the vise head help hold the fly tube steady. Comes with a c-clamp.

ODYSSEY SPIDER VISE

NEW!

Code: G-V-10 (Pictured)

An entry level Odyssey vise. Excellent quality at an affordable price.

Griffin vises are constructed using the finest materials available and carry a Lifetime Guarantee.





Griffin Accessories

WISE ACCESSORIES

- G-V-06 Odyssey Conversion Kit**
Works with the Superior 3A Rotary C-Clamp, Superior 3AR Rotary Pedestal and Patriot Rotary Pedestal/C-Clamp to easily convert to a true rotating vise with all the features of an Odyssey vise.
- G-VO Vise Offset**
Allows for greater flexibility in positioning the vise. Fits c-clamp and pedestal models.
- G-PED Pedestal Base Only**
Can be used with any vise that has a 3/8" stem. Constructed of heavy steel weighing approximately 4 lbs. with a rubber pad on the bottom to protect against scratching.



- G-HG Hackle Gauge**
Fits most vise stems. This gauge will rotate freely on the vise stem so it may be swung out of the way when not in use.
- G-CA Collect-all Wastebasket**
Keeps the work space clean.
- G-BP Extended Body & Parachute Set**
Will fit most vises with a 3/8" stem.
- G-CRA Bobbin Cradle**
Can be used as a bobbin cradle or a bobbin rest. Fits all vises with a 3/8" stem and comes with a 4" extension arm that gives it more flexibility.

Regal™ Vises

Regal™ vises are world-renowned for their quality and durability. Regal™ Engineering guarantees its vises to be free of defects in materials and workmanship for the life of the registered owner.

INEX
Code: RG-RC2
A standard, non-rotary vise.

ROTARY CLAMP VISE
Features 360° rotation, 220° up and down movement and adjustable tension knob.

- RG-RCS5 Standard Jaws (Pictured)
- RG-RCSM8 Mini Jaws

ROTARY BRONZE PEDESTAL VISE
Features 360° rotation, 220° up and down movement, adjustable tension knob.

- RG-RPS7 Standard Jaws (Pictured)
- RG-RPSM10 Mini Jaws (Pictured)

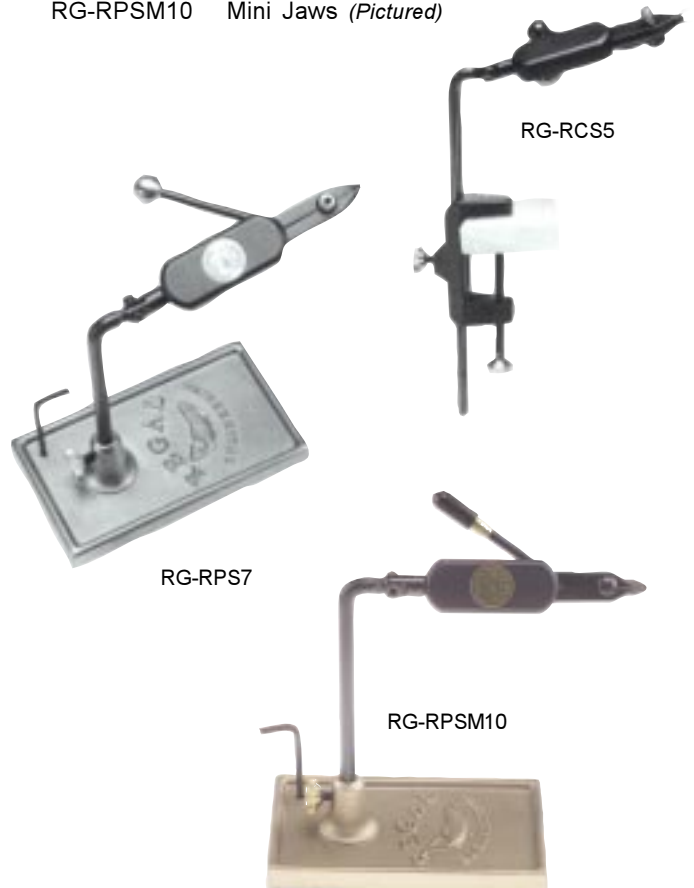

Regal® Engineering, Inc.

Thompson Vises & Accessories

VICES

COBRA

NEW!

Code: TH-COB-V (Pictured)

Totally rotational, it features a unique open architecture based on simplicity and function. Spherical hole patterns along the arc provide a unique way of positioning the detachable 2X Magnifying Mirror, Hackle Gauge, Bobbin Rest and Dual Material Clip.

COBRA VISE ACCESSORIES

- TH-COB-M Cobra 2X Magnifying Mirror
- TH-COB-HG Cobra Hackle Gauge
- TH-COB-BR Cobra Bobbin Rest
- TH-COB-MC Cobra Dual Material Clip



PRO-VISE

Code: TH-PRO-01 (Pictured)

The industry work horse. Economical, but extremely well-made. Suitable for any level tyer.

MODEL "A" VISE

Code: TH-A-01 (Pictured)

Extremely easy to use, with Thompson's single action cam adjustment feature.



WISE ACCESSORIES

NEW!

We have expanded our Thompson product offering to include the innovative Cobra vise and its accessories.

- TH-SUPER-J Super Jaws
- TH-MIDGE-J Midge Jaws
- TH-WISE-M 2X Magnifying Mirror
- TH-CON-B Conversion Base

All Thompson vises are
guaranteed for a lifetime.



CHUBBY TOOLS

NEW!

Thompson's ergonomic Chubby Tools are perfectly hand-weighted tools that will never roll from a tying table!

- TH-CHUB-B Bodkin
- TH-CHUB-BT Bobbin Threader
- TH-CHUB-D Dubbing Teaser

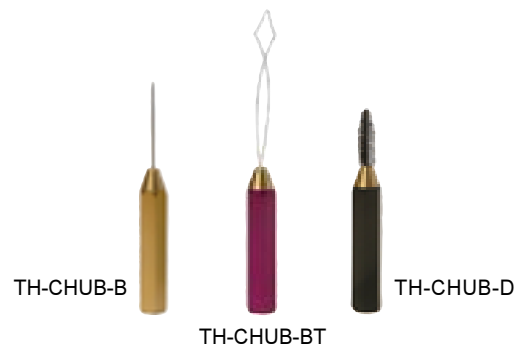



Scissors

SUPERFLY™ BEST VALUE

6 SAME CODE LESS 5%

All SUPERFLY™ Best Value Scissors are pictured below.

- A-1405 Iris Scissors**
Specially made scissors with extra fine blades and a long body.
- A-1406 Spring Scissors**
Spring scissors with screw opener.
- A-1421 3" Deluxe Scissors**
Fine point heavy body blades.
- A-1422 Bent Scissors**
- A-1426 Fine Serrated Scissors**
- A-1427 Midge Scissors**
Spring action scissors suitable for working on Midge flies.
- A-1504 Scissor Clamps**
5-function stainless steel plier with serrated scissors, hook disgorger, screw driver, lead shot pincher and serrated jaws.
- A-6001 3" Straight Scissors**
- A-6002 3" Curved Scissors**
- A-6004 3.5" Solingen Scissors**
- A-6010 4" Special Spring Scissors**
Long spring arm straight scissors with fine blades.

ANVIL

Anvil's unique Accu-Tip precision points reduce point thickness and width by more than 25%. All Anvil scissors feature stainless steel construction and ice tempering that give extra cutting life.



- ANV-20A Accu-Tip Quick Snip - Straight
- ANV-20CA Accu-Tip Quick Snip - Curved
- ANV-40A Bio-Tek Accu-Tip Offset - Straight
- ANV-40CA Bio-Tek Accu-Tip Offset - Curved
- ANV-50A Slimline Accu-Tip - 3" Straight
- ANV-50CA Slimline Accu-Tip - 3" Curved
- ANV-60A Slimline Accu-Tip - 4.25" Straight
- ANV-60CA Slimline Accu-Tip - 4.25" Curved
- ANV-50LA Slimline Accu-Tip 'Lefty' - 3" Straight
- ANV-50LCA Slimline Accu-Tip 'Lefty' - 3" Curved
- ANV-60LA Slimline Accu-Tip 'Lefty' - 4.25" Straight
- ANV-60LCA Slimline Accu-Tip 'Lefty' - 4.25" Curved
- ANV-61A Darrel Martin Long Reach Offset Scissor - Features an offset bend that removes the hand and handles from the cutting path for unrestricted visibility.
- ANV-70 Ultimate - Straight
- ANV-70C Ultimate - Curved
- ANV-71L Ultimate "Lefty" - Straight
- ANV-71LC Ultimate "Lefty" - Curved
- ANV-80T Super Taperizer - 4"
- ANV-90T Ultimate Taperizer - 4.25"

CONTINUED...

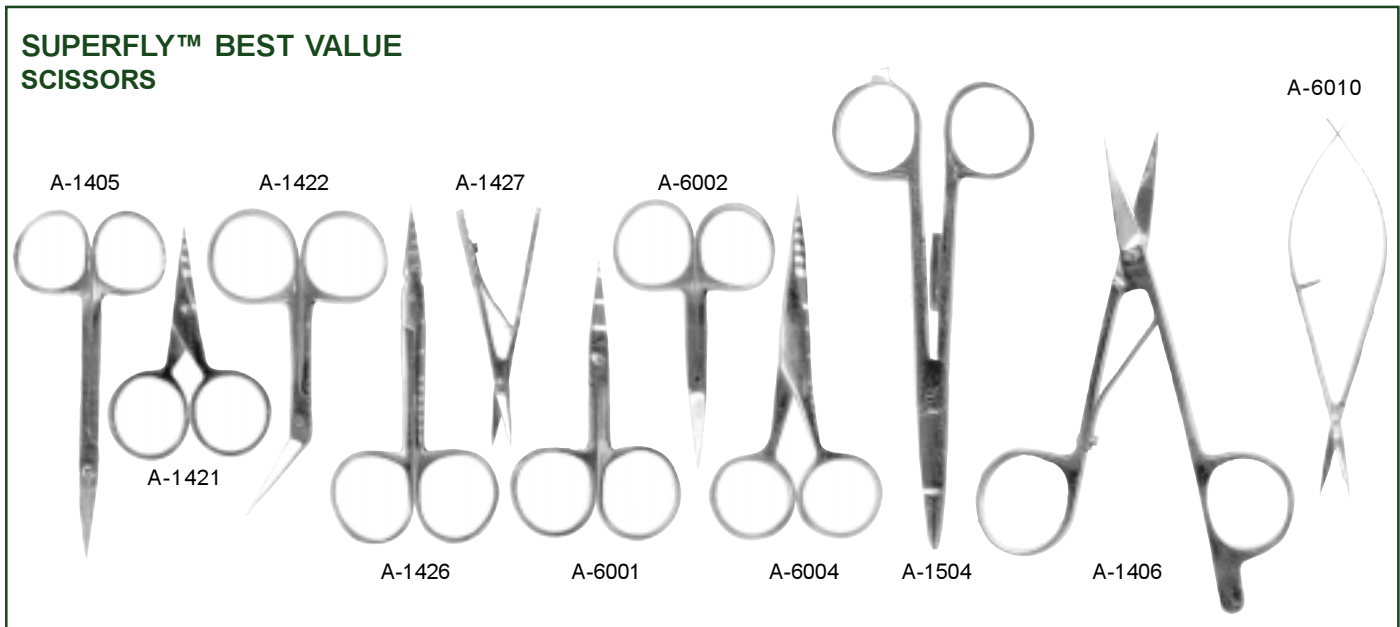

Scissors CONTINUED

TALON™

Outstanding quality precision tools. Pictured at right.

- TT-SC2 3.5" Large Gold Loops, Serrated
- TT-SC210 3.5" Arrow Point, Large Gold Loop
- TT-SC211 3.5" Arrow Point, Large Gold Curved
- TT-SC3 3.5" Arrow Point, Large Serrated
- TT-SC320 3" Folding Scissors
- TT-SC6 3.5" Large Stainless Loops
- TT-SC119 4.25" Large Loop Plastic Handle
- TT-SCL100 4.5" Spring Scissors
- TT-SC4 4" Large Gold Loops
- TT-SC117 4.5" Open Loop Scissors
- TT-SC5 4" Large Gold Loops
- TT-SCL80 4" Scissors/Pliers

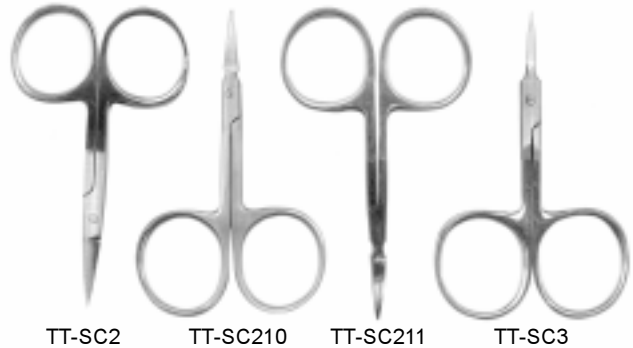

GRIFFIN

- G-SCIS-01 Straight Standard Point**
The edge on one blade is serrated for a sure cutting grip.
- G-SCIS-02 Straight Arrow Point**
Serrated, stainless steel model with a very fine tip for extremely precise detail trimming.
- G-SCIS-04 All-Purpose Scissor**
Comfortable, closed plastic finger loops make for precise control during use.

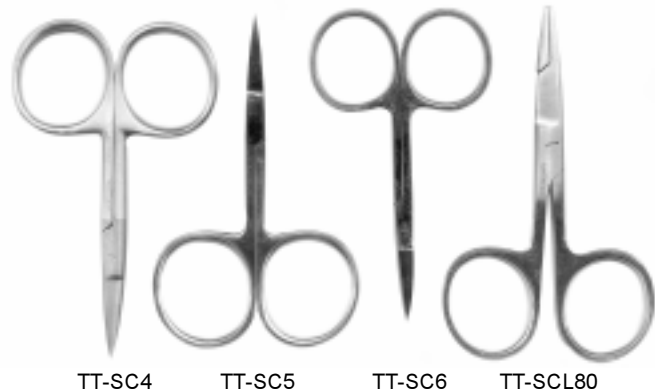

THOMPSON

- TH-SCIS-01 Supreme Scissor**
High quality craftsmanship make these a popular choice for fly tyers.
- TH-SCIS-02 Midge Scissor**

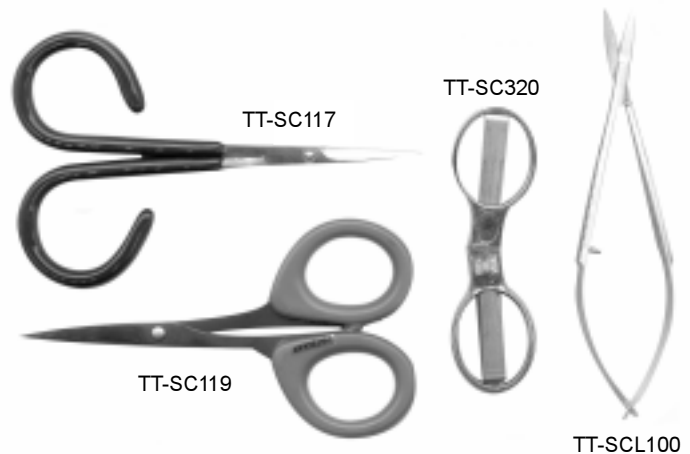



Bobbins

SUPERFLY™ BEST VALUE 6 SAME CODE LESS 5%

All SUPERFLY™ Best Value Bobbins are pictured below.

- A-1103 Midge Bobbin**
Special bobbin with fine tube with both ends flared. Useful for tying flies streamside.
- A-1108 Collar Bobbin**
Fine tube flared on both ends for floss and threads.
- A-1108W Wire Collar Bobbin**
- A-1109 Jig Bobbin - Heavy tube.**
- A-6201 Standard Bobbin - With fine, non-flared tube.**
- A-6203 Material Bobbin - With heavy tube.**
- A-6206 Thumb Bobbin**
Flared tube on both ends. Highly polished brass disc for easy grip.
- A-8481 Flared Bobbin - Fine tube flared on both ends.**
- S-8498 Ceramic Bobbin - Fine tube *NEW!***
- S-8499 Ceramic Bobbin - Heavy tube *NEW!***
- RGF-DBOB Ceramic Double Bobbin *NEW!***
Use with different coloured wire, threads or material for unique flies. Comes with 2 spare spools.



GRIFFIN

- G-BOB-01 Supreme Ceramic Bobbin
- G-BOB-02 Standard Bobbin
- G-BOB-03 Flared Bobbin
- G-BOB-04 Pee Wee Ceramic Bobbin
- G-BOB-06 Magnum Ceramic Bobbin
- G-BOB-12 Supermag Adjustable Tension Bobbin
- G-TC Threader/Cleaners (Set of 3)

THOMPSON

- TH-CHUB-BT Chubby Bobbin Threader *NEW!***
- TH-BOB-01 Standard Bobbin
- TH-BOB-02 Midge Bobbin

SUPERFLY™ BEST VALUE BOBBINS

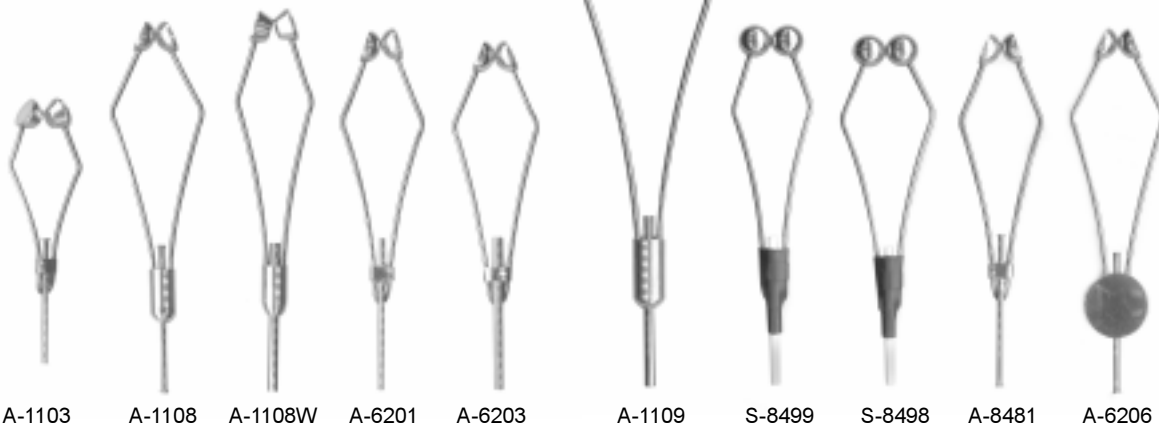

Bodkins

SUPERFLY™ BEST VALUE 6 SAME CODE LESS 5%



A-7004 A-8606 A-8608 A-8609

- A-7004 Standard Bodkin**
- A-8606 Magnetic Bodkin - Large *NEW!***
- A-8608 Bodkin with Half Hitch Tool**
- A-8609 Small Bodkin**

GRIFFIN

- G-BD Bodkin-Dubbing Needle

THOMPSON

- TH-CHUB-B Chubby Bodkin *NEW!***

Dubbing Tools

SUPERFLY™ BEST VALUE 6 SAME CODE LESS 5%

All SUPERFLY™ Best Value Dubbing Tools are pictured below.

- A-1302 Dubbing Loop with Needle
- A-1303 Dubbing Loop with Half-Hitch Tool
- A-619A Dubbing Twister **NEW!**
- A-8601 Large Aluminum Dubbing Twister
- A-8604 Dubbing Hook
- A-8611 Deluxe Dubbing Twister **NEW!**
Includes two attachments
- A-8678 Rougher (Dubbing Teaser)

GRIFFIN

- G-DTE Dubbing Teaser
- G-DTW Dubbing Twister
- G-SLY Spinning Loop Tool

THOMPSON

- TH-CHUB-D Dubbing Teaser **NEW!**



SUPERFLY™ BEST VALUE DUBBING TOOLS



Hackle Pliers

SUPERFLY™ BEST VALUE 6 SAME CODE LESS 5%

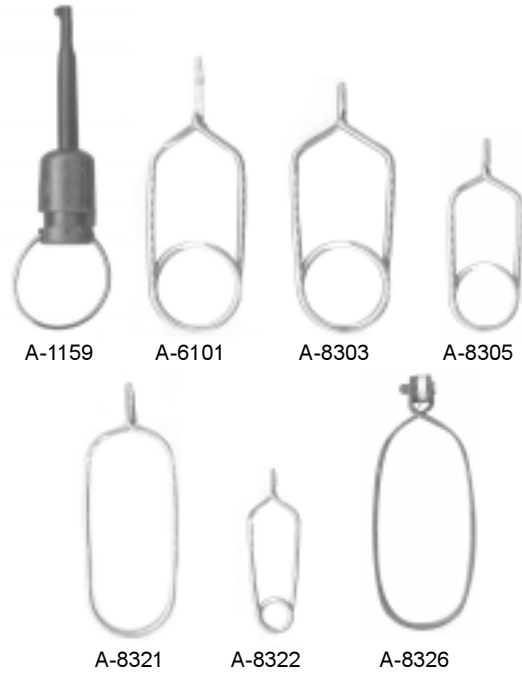

- A-1159 Ezee Hackle Plier**
A metal hook operated by a spring. Plastic body.
- A-6101 Large Hackle Pliers**
- A-8303 English Hackle Pliers - Large**
- A-8305 English Hackle Pliers - Medium**
- A-8321 Brass Hackle Pliers**
- A-8322 Small (Midge) Hackle Pliers**
- A-8326 Non Skid Hackle Pliers**
With brass and rubber tips.
- SF-8303 "Suregrip" Hackle Pliers**
Unique 'tacky' tubing for a positive grip. Tubing won't crack.

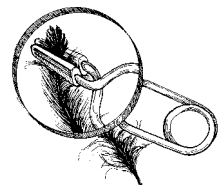

GRIFFIN

- G-HPL-01 Tear Drop Hackle Pliers
- G-HPL-02 Rotating Hackle Pliers



Whip Finishers

SUPERFLY™ BEST VALUE 6 SAME CODE LESS 5%

All SUPERFLY™ Best Value Whip Finishers are pictured below.

- A-1203 Improved Whip Finisher
- A-1207 Roto Whip Finisher
- A-6301 Whip Finisher - Standard
- A-6302 Whip Finisher - Mini
- A-6305 Rotating Whip Finisher - Matarelli Style

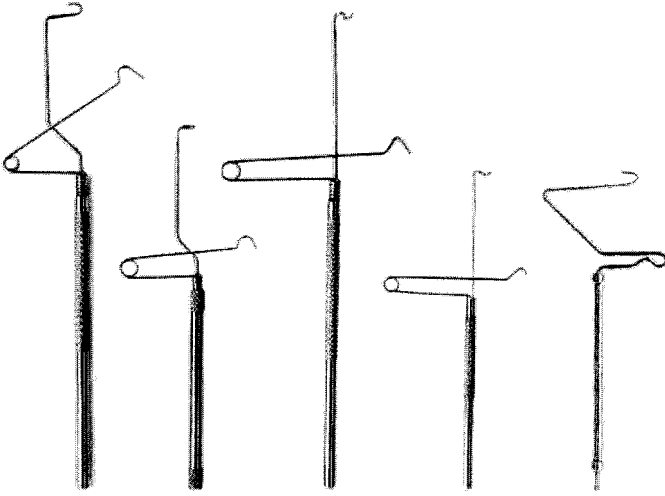

A-1203 A-1207 A-6301 A-6302 A-6305

GRIFFIN

G-WHIP-02 Non-Rotating Whip Finisher

THOMPSON

TH-WHIP-01 Whip Finisher

Hair Tools

SUPERFLY™ BEST VALUE 6 SAME CODE LESS 5%

- A-1275 Wooden Hair Stacker
- A-8652 Standard Hair Stacker (Not Pictured)
- A-8655 Hair Stacker - 4-Piece Set
- A-710 Hair Stacker - Shoehorn **NEW!**

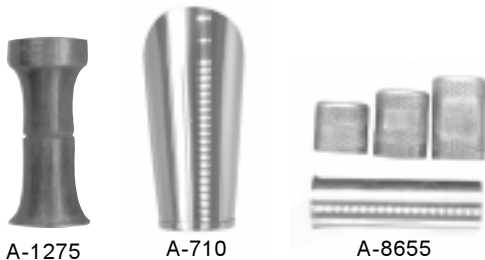

A-1275 A-710 A-8655

ANVIL

ANV-2000 Brass Hair Packer

GRIFFIN

- G-HE-01 Regular Hair Stacker
- G-HE-02 Adjustable Hair Stacker
- G-HE-03 Large Hair Stacker
- G-BT Bullet Head Tool

THOMPSON

- TH-STACK-01 Standard Hair Stacker
- TH-STACK-02 Midge Hair Stacker

WHITETAIL

- BRASS-01 Brassie™ Hair Packer (2/0 - 6/0)
- BRASS-02 Brassie™ Hair Packer (1/0 - 8)
- BRASS-03 Brassie™ Hair Packer (10 - 18)

Specialty Tying Tools

SUPERFLY™ BEST VALUE 6 SAME CODE LESS 5%

- A-0311 Hook and Hackle Gauge
- A-1231 Hackle Guard*
Set of 3 pieces for different hook sizes.
- A-1232 English Hackle Guard*
Five hole sizes for finishing the head of a fly.
- A-783 Leg Tool* **NEW!**
- A-8629 Half Hitch Tool* - Set of 2
- A-8661 Wing Burner - Mayfly
- A-8662 Wing Burner - Stonefly
- A-8663 Wing Burner - Caddis
- A-8665 Wing Cutter* - Set of 4

* Pictured Below

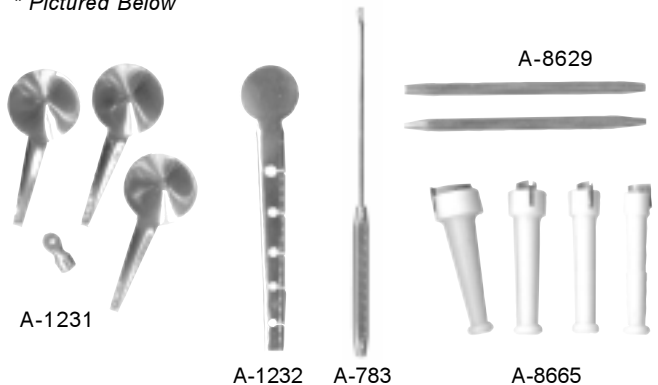

A-1231 A-1232 A-783 A-8629 A-8665

GRIFFIN

G-HG Hackle Gauge

RAINY'S™

- RS501PT Premium E-Z Leg Tool - Small
- RS502PT Premium E-Z Leg Tool - Medium

Tying Accessories

SUPERFLY™ BEST VALUE 6 SAME CODE LESS 5%

All SUPERFLY™ Best Value Tying Accessories are pictured below.

- A-7007 Chrome Threader/Cleaner
- A-8624 4" Straight Tweezers
- A-8625 4" Curved Tweezers
- A-8804 6" Scissors Pliers
- A-8820 5.5" Needle Nose Plier

TALON

- TT-SCL50 3-piece Tweezer Set
- TT-SCL80 4" Scissors/Pliers

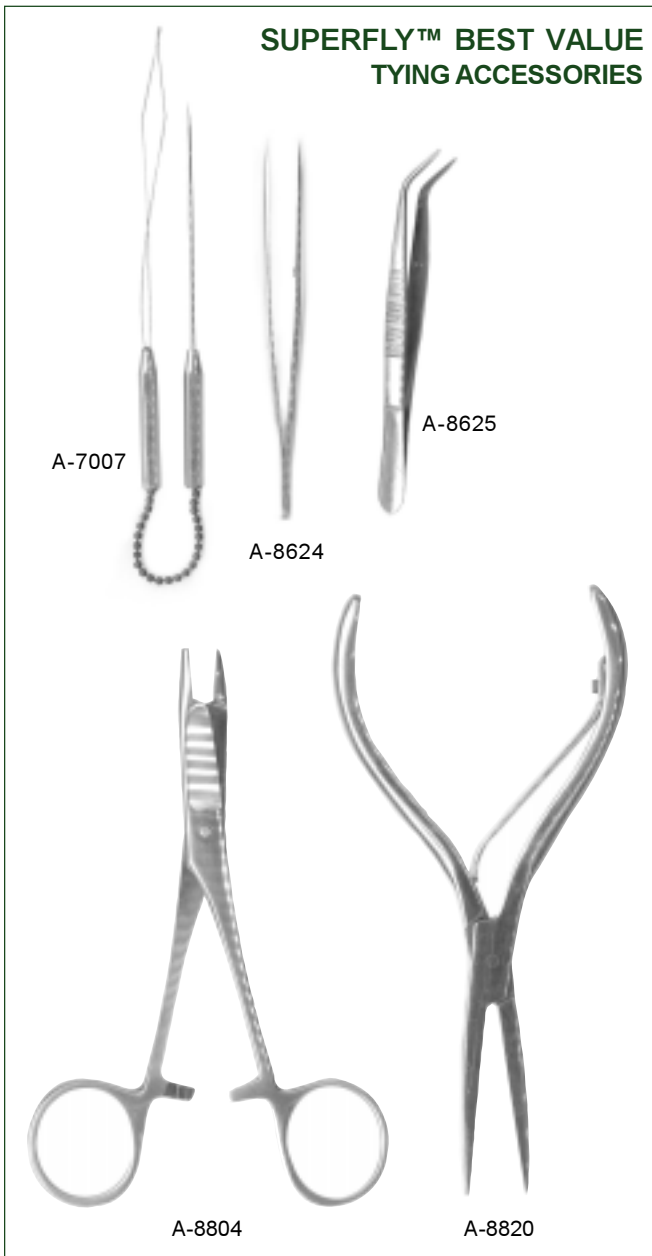

Tying Tool Kits

SUPERFLY™ BEST VALUE

CROWN VISE TOOL KIT

Code: A-1700

Packaged in an attractive wood presentation box.

- Contains: Crown Vise
- | | |
|-------------------|----------------------|
| Scissors | Bodkin |
| Whip Finisher | Half Hitch Tools (3) |
| Hackle Pliers (2) | Tweezers |
| Dubbing Twister | Bobbin |
| Hair Stacker | Bobbin Threader |

SUPER AA VISE TOOL KIT

NEW!

Code: A-1720

Packaged in an attractive wood presentation box.

- Contains: AA Vise
- | | |
|---------------|-----------------|
| Scissors | Bodkin |
| Whip Finisher | Bobbin |
| Hackle Pliers | Bobbin Threader |

STANDARD TYING TOOL KIT WITHOUT VISE

Code: A-1750

Packaged in a zippered carrying case.

- Contains: Scissors
- | | |
|-------------------|----------------------|
| Scissors | Bodkin |
| Whip Finisher | Half Hitch Tools (3) |
| Hackle Pliers (2) | Bobbin Threader |
| Bobbin | |

GRIFFIN

DELUXE FLY TYING TOOL KIT WITH 2A VISE

Code: G-FTK

Packaged in a zippered carrying case.

- Contains: Superior 2A Vise
- | | |
|----------------------|------------------------|
| Superior 2A Vise | Bodkin |
| Supreme Bobbin | Hair Evener |
| Hackle Pliers | Rotating Whip Finisher |
| Threader-Cleaner | Hook/Hackle Gauge |
| All Purpose Scissors | |

TALON™

4-PIECE TOOL KIT

Code: TT-AL30

Packaged in a zippered carrying case.

- Contains: Scissors (2)
- Mitten Clamp
 - Tweezers with Pouch

SUPERFLY™ Fly Tying Kits

Great as an introduction to the craft, or as a One-Stop-Shop for the seasoned tyer, there is a kit for every level. Kits include Superfly's bilingual Fly Tying Manual and are packaged in clear plastic boxes with hang tags.

BEGINNER KIT

All the necessary tools and materials to get a good start.

Code: KIT-01

Contents:

Fly Tying Manual	
Calf Tail	Mallard Flank
Chenille (4)	Marabou (2)
Duck Quills	Neck Hackle (2)
Fine Wire	Peacock Herl
Floss	Pheasant Tail
Fly King Vise	Scissors
Fur Dubbing	Thread
Gldn. Pheasant Tippetts	Tinsel
Head Cement	Tying Tools
Hooks (15)	

BASIC KIT

The Basic fly tying kit has sufficient materials to learn and produce Dry Flies, Wet Flies, Nymphs and Streamers. Materials included will tie the "bread and butter" flies that are consistently effective.

Code: KIT-02

Contents:

Fly Tying Manual	
Calf Tail	Mallard Flank
Chenille (4)	Marabou (2)
Deer Hair	Neck Hackle (2)
Duck Quills	Peacock Herl
Fine Wire	Pheasant Tail
Floss	Polypropylene
Fly King Vise	Rubber Hackle
Fur Dubbing	Scissors
Gldn. Pheasant Tippetts	Thread
Head Cement	Tinsel
Hooks (30)	Tying Tools

INTERMEDIATE KIT

The Intermediate builds on the *Basic* kit, containing a greater variety of materials and hooks to allow the tyer to produce more patterns.

Code: KIT-03

Contents:

Fly Tying Manual	
Calf Tail	Mallard Flank
Chenille (4)	Marabou (3)
Deer Hair	Neck Hackle (2)
Duck Quills	Oval Tinsel
Fine Wire	Peacock Herl
Flat Tinsel	Pheasant Tail
Floss	Pheasant Rump
Fur Dubbing	Polypropylene (3)
Gldn. Pheasant Tippetts	Rubber Hackle (2)
Grizzly Body Plumage	Scissors
Head Cement	Thread
Hooks (150)	Tying Tools
Knob Vise	

EXPERT KIT

Quality tools and our largest selection of materials, makes *The Expert* the "Everything-you-will-ever-need" kit!

Code: KIT-04

Contents:

Fly Tying Manual	
Calf Tail	Mallard Flank (2)
Chenille (4)	Marabou (3)
Chinese ½ Cape	Mylar Piping
Deer Hair	Neck Hackle (2)
Duck Quills (2)	Oval Tinsel
Fine Wire	Peacock Herl
Flat Tinsel	Pheasant Tail
Floss	Pheasant Rump
Fur Dubbing (2)	Polypropylene (3)
Gldn. Pheasant Tippetts	Rubber Hackle (2)
Grizzly Body Plumage	Saddle Hackle
Grizzly Saddle	Scissors
Head Cement	Super AA Vise
Hooks (200)	Thread
Indian ½ Cape	Tying Tools

We assemble all kits in-house
giving you the perfect opportunity to
produce custom kits for your stores.

Call us for details.

Notes

